

EDSON PUMPS®

Installation & Operations Manual

Electric Double Diaphragm Pump

Part Numbers: 25220 | 25230 | 25240 | 25250 | 25260



The 25260 shown above was assembled with a 30 to 1 Ratio Gear Reducer, an optional 3/4HP Motor and the optional Wheels and Handle.

The Ratio of the Gear Reducer defines the Part Number of your Pump:

30 to 1 Order Part Number 25260

34 to 1 Order Part Number 25250

43 to 1 Order Part Number 25240

60 to 1 Order Part Number 25230

83 to 1 Order Part Number 25220

Circle the Part Number that applies to your Pump

Pump Configuration & Dimensions

The 25260 25250 25240 25230 25220 pumps can be purchased with a number of optional motors. The version of the pump and the rpm of the motor ordered with the pump determines the performance you should expect. The ratio specified on the legend plate of the pump gear reducer and the rpm specified on the motor legend will inform you of the pump cycle rate per minute. The cycle rate and the back pressure caused by the head conditions of the application determine the diaphragm pump's output.

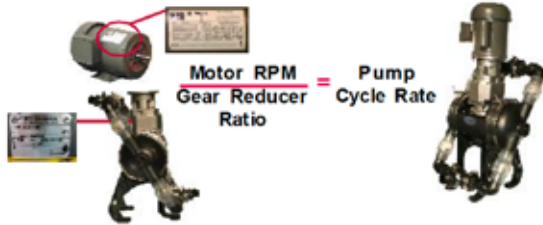

Example: If the Order No. for your pump is 25260. It is built with a 30 to 1 gear reducer. If the motor ordered with your pump is Order No. 161-A-1432 a 3/4hp/12VDC/1800RPM Motor. The cycle rate is 1800 divided by 30 = 60 cycles per minute

		Pump Part Number & Gear Reduction				
		25260	25250	25240	25230	25220
		30	34	43	60	83
Typical Motor RPMs	1150	38.3	33.8	26.7	19.2	13.9
	1425	47.5	41.9	33.1	23.8	17.2
	1725	57.6	50.7	40.1	28.7	20.8
	1745	58	51.3	40.6	29.1	21
	1800	60	52.9	41.8	30	21.7
	2850				47.5	34.3
3450				57.5	41.5	

Pump Cycle Rates Per Minute

- 161-G-2500-WH is the order number for the optional Handle & Wheels for a 2500 pump.



Dimensions: Shown below are the dimension drawings of a 2500 series pump. The first 3 are for the standard pump orientation. However because of the way the pump is built the pump drive and mounting assembly can be rotated forward or backwards on the support legs. Also the pump base assembly that includes the suction and discharge plumbing can be rotated on the pump frame. Rotating either or both assemblies will change the pump dimensions as shown by the 4th drawing.

Caution: Rotating the pump frame and drive assembly requires that the pump frame support legs be bolted down or the pump will tip due to the overhung weight of the motor.

Caution: Do not rotate the pump base and plumbing beyond horizontal or the flapper check valves will not work and the pump will not pump.

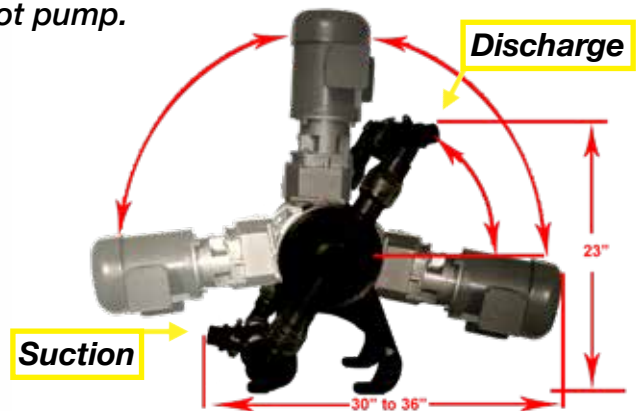
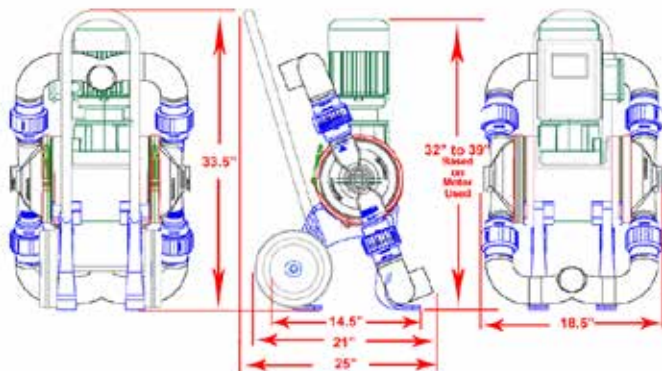

Pump Specifications & Performance

Pump Performance:

- Max Volume - 25 GPM | 94.6 LPM | 5.68 M³HR
- Suction Lift to 25 feet | 7.62 meters
- Dry Prime Suction Lift to 12 feet | 3.657 meters
- Discharge Head to 25 feet | 7.62 meters

Pump Construction:

- 2 Polypropylene Pump Bodies
- Inlet & Discharge Ports - 1.5" MNPT Polypropylene
- Diaphragm - (Viton or Neoprene)
- Valve Assembly - Flapper Type: (Viton or Neoprene)
- Optional Stainless Handle & (4) 8-inch Wheels

Pump Models (25260 | 25250 | 25240 | 25230 | 25220)

Built with a choice of Fixed Speed Motor & Gear Reducer

- Motors: .75hp/.55kw; Any Voltage; Any Phase; Any Hertz; TEFC or Xp with 56C Frames
- Gear Reducers: 5 Gear Reducers Available for Matching Pump Performance to Application

Volume Performance: The following chart provides an estimate of the volume output of an Edson 2500 Electric Powered Double Diaphragm Pump operating at 4 different cycle rates. This chart was created by measuring the output volume under 25 different specific combinations of suction pressure (inches of mercury, Hg) and discharge pressure (pounds per square inch, PSI) for each cycle rate. On the chart these pressure settings are equated to suction and discharge head in both feet and meters.

Results In Gallon Per Minute
1 Gallon Per Min. = 3.785 Liters Per Min. = .2271 Cubic Meters Per Hour

60 Cycles / Min		Discharge Head				
		5ft / 1.52m	10ft / 3.04m	20ft / 6.09m	25ft / 7.62m	
		0	2.2 psi	4.4 psi	8.7 psi	10.8 psi
Suction Head	0	25.0 gpm	21.4 gpm	20.0 gpm	16.7 gpm	12.5 gpm
5ft / 1.52m	4.5hg	25.0 gpm	21.4 gpm	20.0 gpm	16.7 gpm	12.5 gpm
10ft / 3.04m	9.1hg	21.4 gpm	16.7 gpm	14.3 gpm	11.5 gpm	11.1 gpm
20ft / 6.09m	18.2hg	18.8 gpm	16.7 gpm	12.3 gpm	10.7 gpm	10.3 gpm
25ft / 7.62m	22.7hg	15.0 gpm	14.3 gpm	11.5 gpm	10.7 gpm	10.0 gpm

40 Cycles / Min		Discharge Head				
		5ft / 1.52m	10ft / 3.04m	20ft / 6.09m	25ft / 7.62m	
		0	2.2 psi	4.4 psi	8.7 psi	10.8 psi
Suction Head	0	15.8 gpm	12.5 gpm	11.5 gpm	10.0 gpm	9.4 gpm
5ft / 1.52m	4.5hg	15.0 gpm	12.5 gpm	11.5 gpm	10.0 gpm	9.4 gpm
10ft / 3.04m	9.1hg	13.6 gpm	11.5 gpm	10.3 gpm	8.8 gpm	8.8 gpm
20ft / 6.09m	18.2hg	12.5 gpm	11.1 gpm	9.4 gpm	6.3 gpm	5.0 gpm
25ft / 7.62m	22.7hg	10.0 gpm	9.4 gpm	6.0 gpm	5.0 gpm	4.4 gpm

30 Cycles / Min		Discharge Head				
		5ft / 1.52m	10ft / 3.04m	20ft / 6.09m	25ft / 7.62m	
		0	2.2 psi	4.4 psi	8.7 psi	10.8 psi
Suction Head	0	12.0 gpm	10.7 gpm	10.0 gpm	8.3 gpm	7.9 gpm
5ft / 1.52m	4.5hg	10.7 gpm	10.7 gpm	7.5 gpm	5.6 gpm	5.0 gpm
10ft / 3.04m	9.1hg	10.0 gpm	8.8 gpm	6.7 gpm	5.0 gpm	4.5 gpm
20ft / 6.09m	18.2hg	8.3 gpm	7.1 gpm	5.0 gpm	4.2 gpm	3.8 gpm
25ft / 7.62m	22.7hg	7.1 gpm	6.0 gpm	4.3 gpm	3.8 gpm	3.5 gpm

20 Cycles / Min		Discharge Head				
		5ft / 1.52m	10ft / 3.04m	20ft / 6.09m	25ft / 7.62m	
		0	2.2 psi	4.4 psi	8.7 psi	10.8 psi
Suction Head	0	6.3 gpm	6.0 gpm	4.7 gpm	4.3 gpm	4.1 gpm
5ft / 1.52m	4.5hg	6.0 gpm	4.7 gpm	4.1 gpm	3.3 gpm	3.0 gpm
10ft / 3.04m	9.1hg	6.0 gpm	4.1 gpm	3.5 gpm	3.0 gpm	2.9 gpm
20ft / 6.09m	18.2hg	5.0 gpm	3.3 gpm	3.0 gpm	2.6 gpm	2.4 gpm
25ft / 7.62m	22.7hg	4.4 gpm	3.0 gpm	2.3 gpm	2.1 gpm	1.9 gpm

Pump Parts List

25260 | 25250 | 25240 | 25230 | 25220 Pumps

Pump Drive Components

① **Motor** Check Legend Plate For Specifications (QTY 1)
The following is a partial list of replacment motors

60 Hertz Totally Enclosed Fan Cooled Motors



Part Number	Description
161-A-161	3/4Hp 115/208-230V 60Hz 1745Rpm 1Ph TEFC Motor
161-A-1429	3/4Hp 208-230/460V 60Hz 1745Rpm 3Ph TEFC Motor

12 Volt Totally Enclosed Fan Cooled Motors



Part Number	Description
161-A-1432	3/4Hp 12 Volt DC 1800Rpm TEFC Motor
161-A-1433	3/4Hp 24 Volt DC 1800Rpm TEFC Motor

12 Volt Totally Enclosed Fan Cooled Motors



Part Number	Description
161-A-1430	3/4Hp 115/208-230V 60Hz 1725Rpm 1Ph Explosion Proof Motor
161-A-1431	3/4Hp 208-230/460V 60Hz 1725Rpm 3Ph Explosion Proof Motor
161-A-1556	3/4Hp 115/208-230V 50Hz 2850Rpm 3Ph Explosion Proof Motor
161-A-1557	3/4Hp 208-230/460V 50Hz 1425Rpm 3Ph Explosion Proof Motor

50 Hertz Totally Enclosed Fan Cooled Motors



Part Number	Description
161-A-1501	3/4Hp 115/208-230V 50Hz 2850Rpm 1Ph TEFC Motor
161-A-1558	3/4Hp 115/208-230V 50Hz 1425Rpm 1Ph TEFC Motor
161-A-1559	3/4Hp 208-230/460V50Hz 2850Rpm 3Ph TEFC Motor
161-A-1560	3/4Hp 208-230/460V50hz 1425Rpm 3Ph TEFC Motor

② **Gear Reducer** 1 of 5 Check Legend Plate for Specifications (QTY 1)

Part Number	Description
<i>(All Gear Reducers Include part no. 3, a 161-A-1810-B Coupling.)</i>	
161-A-2984	Gear Reducer 30:1 C-Face Flange Mount For Pump 2560
161-A-2985	Gear Reducer 34:1 C-Face Flange Mount For Pump 2560
161-A-2986	Gear Reducer 43:1 C-Face Flange Mount For Pump 2540
161-A-2987	Gear Reducer 60:1 C-Face Flange Mount For Pump 2530
161-A-2988	Gear Reducer 83:1 C-Face Flange Mount For Pump 2520

Part Number	Description
③ 161-A-1810-B	Reducer To Motor Coupling (QTY 1)
④ 161-C-810	Motor Mount (QTY 1)
⑤ 161-G-2814	Eccentric (QTY 1)
⑥ 161-C-805	Piston (QTY 1)

Pump Head Components

Part Number	Description
⑦ 25273 (OR) 25274	Neoprene Diaphragm (QTY 2) (OR) Viton Diaphragm (QTY 2)
⑧ 160-B-1278	V-Clamp for Pump Base (QTY 2)
⑨ 160-A-2813-SS	Lower Standard (QTY 2)
⑩ 160-A-2815-SS	Standard Bolt (QTY 2)
⑪ 160-D-361	Pump Base - Poly (QTY 2)
⑫ 160-A-2838	Viton O-Ring 2" X 1.75" X 0.125" (QTY 2)
⑬ 160-A-2245	Pump Base Plug (QTY 2)

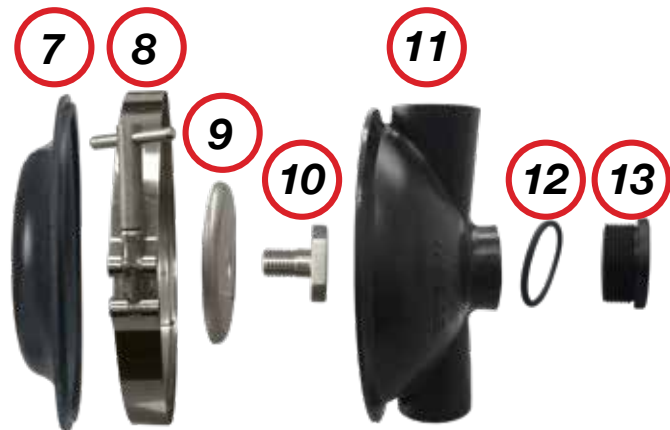

Pump Parts List Continued

Suction & Discharge Port Components

Part Number	Description
14 160-G-301	Port Assembly (Suction & Discharge) 1.5" (QTY 2) <i>(Does Not Include Camlock Adapter Show in Photo)</i>
15 269P-150 <small>(OR)</small>	Check Valve (Poly) - Neoprene Flapper <small>(QTY 4)</small> <small>(OR)</small>
269P-150V	Check Valve (Poly) - Viton Flapper (QTY 4)



Discharge Orientation

Replacment Flapper Valve Assembly for Check Valve

Part Number	Description
16 160-G-302 <small>(OR)</small>	Neoprene Flapper Valve <small>(OR)</small>
160-G-302V	Viton Flapper Valve



Suction Orientation

Replacment Flapper Valve Parts Breakdown



Part Number	Description	Quantity
A 160-G-2886 <small>(OR)</small>	Neoprene O-Ring	2
160-G-2886V	Viton O-Ring	
B 160-G-2885-NEO <small>(OR)</small>	Neoprene Seal	2
160-G-2885	Viton Seal	
C F1032-1/4-PHP-P	F1032 Screw (Secures Seal to Housing)	2
D F1/4-1/2-PHP-PP	F1/4 Screw (Secures Weights to Seal)	1
E 160-G-2249-A	Bottom Weight	1
F 160-G-2249B	Top Weight	1
G 160-A-2248	Flapper Valve Housing	1

Mounting Frame Assembly

Part Number	Description
17 160-C-804	Pump Frame PVC SCH 120 (QTY 1)
18 160-A-2897	Stainless Clamp 8.61-9.19 Clamping Range (QTY 1)
19 161-D-390-R <small>AND</small>	Right Pump Leg (QTY 1) <small>AND</small>
161-D-390-L	Left Pump Leg (QTY 1)
20 161-A-2902	Leg Connecting Rod (QTY 1)

Optional Parts (Included When Ordered)

Part Number	Description
21 161-A-166	Wheel (QTY 4)
22 161-A-2903	28.3-inch Stainless Handle (QTY 1)



Double Diaphragm Pump - Flapper Valve Assembly

STEP 1 | O-Ring Installation

Take the two O-Rings (160-G-2886 Neoprene; 160-G-2886V Viton) and place them into the two milled out grooves on either side of the Flapper Valve Housing (160-A-2248).

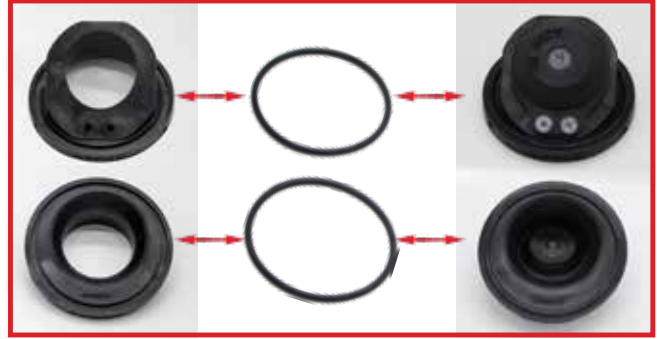

STEP 2 | Flapper Assembly

The parts needed to assemble to Flapper consists of: One Rubber Seal (160-A-2885-NEO Neoprene; 160-G-2885 Viton), One F1/4 Screw (F1032-1/4-PHP-P), One Top Weight (160-G-2249B), and One Bottom Weight (160-G-2249).



1. Take the Rubber Seal (160-A-2885-NEO Neoprene; 160-G-2885 Viton), and place the Top Weight (160-G-2249B) on top of it.

2. Take the F1/4 Screw (F1032-1/4-PHP-P) and push it through the Top Weight (160-G-2249B) and the Rubber Seal (160-A-2885-NEO Neoprene; 160-G-2885 Viton)



3. Take the Bottom Weight (160-G-2249) and place it on top of the F1/4 Screw (F1032-1/4-PHP-P). Then while holding the bottom weight tighten the screw.



Part Number	Description
#160-G-303-N	(1) Neoprene Seal
	(1) F1/4 Screw
	(2) F1032 Screw
#160-G-303-V	(1) Viton Seal
	(1) F1/4 Screw
	(2) F1032 Screw

STEP 3 | Flapper Installation

Now with the Flapper assembled we can install it onto the Housing. Take the previously assembled Flapper and place it on top of the Flapper Valve Housing (160-A-2248). Line up the two holes on the Flapper and the Housing, take the two F1032 Screws (F1032-1/4-PHP-P) and screw them into place, securing the Flapper to the Housing.



Plumbing A Diaphragm Pump



WARNING



DO NOT SHUT OFF DISCHARGE WHEN THE PUMP IS RUNNING

Edson Model 2500 Pumps are positive displacement pumps, they will continue to try to pump liquid through a closed line. The pressure created will cause damage to the pump.

For The Same Reason

DO NOT PLACE THE PUMP IN A SITUATION WHERE THE DISCHARGE LINE WILL BE CLOSED WHILE THE PUMP IS RUNNING

Unless an automatic high amp or high pressure shut-off switch is used



- **USE ONLY NON-COLLAPSING HOSE AND/OR PIPE ON THE SUCTION AND DISCHARGE OF THE PUMP**

- **WHEN PUMPING LIQUIDS WITH SUSPENDED SOLIDS, THE DISCHARGE PLUMBING CAN BE THE SAME SIZE OR LARGER BUT NEVER SMALLER THAN THE SUCTION.**

(Because a smaller discharge line increases the possibility of clogging)

- **WHENEVER POSSIBLE INSTALL THE PUMP AND DISCHARGE PLUMBING SO AIR CANNOT BE TRAPPED IN THE DISCHARGE PLUMBING.**

(Because trapped air will severely restrict flow and require more work from the pump resulting in early diaphragm failure. Install pump and plumbing so any air introduced into the plumbing will not be trapped but flow naturally through liquid and out of the system.)

- **TAKE APPROPRIATE PRECAUTIONS WHEN INSTALLING THE PUMP BELOW THE LIQUID BEING TRANSFERED.**

(Because installing the pump on a positive suction head, the force of gravity will cause the liquid to flow right through a diaphragm pump even when it is not running. There is no internal shut off in a check valved diaphragm pump to stop the siphon effect of a positive suction head.)

- **DRY START SELF PRIMING IS REQUIRED FOR A PUMP OUT APPLICATION.**

The Edson 2500 pumps will develop a dry start vacuum equal to 10.5 hg. After the pump chambers are full (primed) the suction lift will increase to 23 hg. You can maintain a primed pump chamber and the 23 hg by installing optional high suction lift plumbing. This plumbing keeps the pump chambers primed even when the suction line runs dry. The result is dry line suction lifts to depth greater than 20ft.

The Self Priming Feature Depends on:

1. An Airtight Suction Line.
2. The Flapper check valves sealing properly. Solids trapped under the check valves will prevent self priming. This can occur when the pump is used in sewage or sump pump out applications. Flushing with water will generally clear out the solid matter.



Plump Maintenance

OVERVIEW:

Except for general cleaning and the as needed replacement of the diaphragms, check valves and O rings, there is no scheduled maintenance program for this pump.

The replacement of the diaphragms, valve assemblies and O rings are going to be determined based on the demands of the particular installation.

Determining those demands and the pumps performance can be evaluated by inspection and testing on a regular basis.

- Life expectancy is directly related to head conditions, run time and diaphragm material. The higher the suction and discharge pressures the shorter the life.
- The 2500 diaphragm is made of Viton. Dynamic testing shows that life expectancy for the Viton diaphragm should be between 650 hrs under extreme head conditions and 1200 hrs under low to moderate head conditions.

TESTING:

- **Vacuum/Pressure Gauge Test - Tests the performance of the pump using an Edson Vacuum/Pressure Test Gauge. Order No. 276-150**
 1. By holding or clamping the gauge into the suction and discharge plumbing you can read the actual vacuum and pressure forces created by the installation.
- **Volume Test - Tests overall performance of the pump installation.**
 1. Use a container with a known capacity of at least 2 gallons.
 2. Empty the container using the suction side of the pump or fill it from the discharge. When using the fill test make sure the pump is fully primed before filling the container.
 3. Use a watch to record the time it takes. Repeat the test at least twice.
 4. Establish GPM rate. Example: It took 10 seconds to empty a 2 gallon container. The GPM rate is 12 Gallons Per Minute. (60 seconds divided by 10 seconds times 2 gal.)
 5. Record the cycle speed of the pump. Know the head conditions of your test and compare the results of your test with the volume of the appropriate Volume Chart on the pump specification sheet. Every installation is different so use the charts as a guideline.
- **Manual Test - Testing the pump valves and valve seals without use of a gauge.**
 1. Remove all fittings from the inlet and discharge of the pump.
 2. Turn on the pump.
 3. Put your hand over the inlet. If the discharge valve is working properly, you should feel a very strong pulsing suction. If you do not feel any suction, do the same thing again and listen for air being sucked in around the diaphragm. If you hear air movement, inspect for loose clamps or worn diaphragm. Tighten and replace as required.
 4. Press your hand over the discharge. If the inlet valve is sealing properly, the pressure of the pump should push your hand away. If it does not and the air is forced out the inlet chamber, inspect the valve assembly. Clean or replace the valve

EDSON DIAPHRAGM & FLAPPER VALVES

Over time these parts wear and need to be replaced. The ability to easily and quickly replace these parts is one of the major advantages of an Edson pump. These parts are available as individual items

Part Number	Description	QYT	Part Number	Description	QYT
25273	Neoprene Diaphragm	2	160-G-302	Neoprene Flapper Valve	2
25274	Viton Diaphragm	2	160-G-302V	Viton Flapper Valve	2

Changing Diaphragms



Step 1. Using a strap wrench to loosen the 4 check valve unions, remove the suction and discharge port assemblies.

Rule 1. Change only one diaphragm at a time.



Step 2. Remove the Pump Base V Clamp by unscrewing the Tee Handle all the way.

Rule 2. Before removing the old and installing the new diaphragm, make sure the piston is pushed back all the way into the pump frame. You can also use the VDF drive on slow speed to do it. This is important. It makes it easier to align and reattach the pump base and the V clamp after changing the diaphragm.



Step 3. Remove the Pump Base. Lay out all these parts for reassembly.

Changing Diaphragms



Step 4. Using a 1/2" drive or a crescent wrench unscrew the diaphragm retaining nut. Replace the old with the new diaphragm and reassemble the lower standard and retaining nut before screwing the assembly back onto the piston. Tighten the nut with the 1/2" drive or wrench.



Step 5. Clamp the pump base back in place. Using your body to hold the pump base in position will leave your hands free to install the V Clamp. Secure the V Clamp just tight enough to keep it in place but also allow rotation of the base.

Step 6. Repeat Steps 2-5 for the 2nd diaphragm.

Rule 3. Make sure the flapper valves for all check valves are installed in the correct orientation.



Step 7. Align the 2 pump bases so the suction and discharge ports are parallel and install the suction and discharge port assemblies with the flapper valves oriented to open in the direction of flow and the flapper hinge at the vertical high point.

Rule 4. Don't forget to tighten all check valve unions and completely tighten the V Clamps.

Changing Flapper Valves

Step 1

To properly install Edson's **Flapper Valve (160-G-302)** into the **Check Valve (269P-150)** you first must make sure the **Flapper Valve (160-G-302)** is in the correct orientation. Make sure the "EDSON" logo and two White Screws on the **Flapper Valve (160-G-302)** is facing the same direction as the **Suction Port**.

Discharge Port



Suction Port



Step 2

Once you have the **Flapper Valve (160-G-302)** facing the same direction as the **Suction Port**, you can insert it into the **Check Valve (269P-150)**. Make sure that the **Flapper Valve (160-G-302)** is going into the part of the **Check Valve** with the **Part Number A2244** imprinted on. This half of the **Check Valve** is where the **Female Threaded Coupler** goes over to create the liquid tight seal for the **Check Valve (269P-150)**.

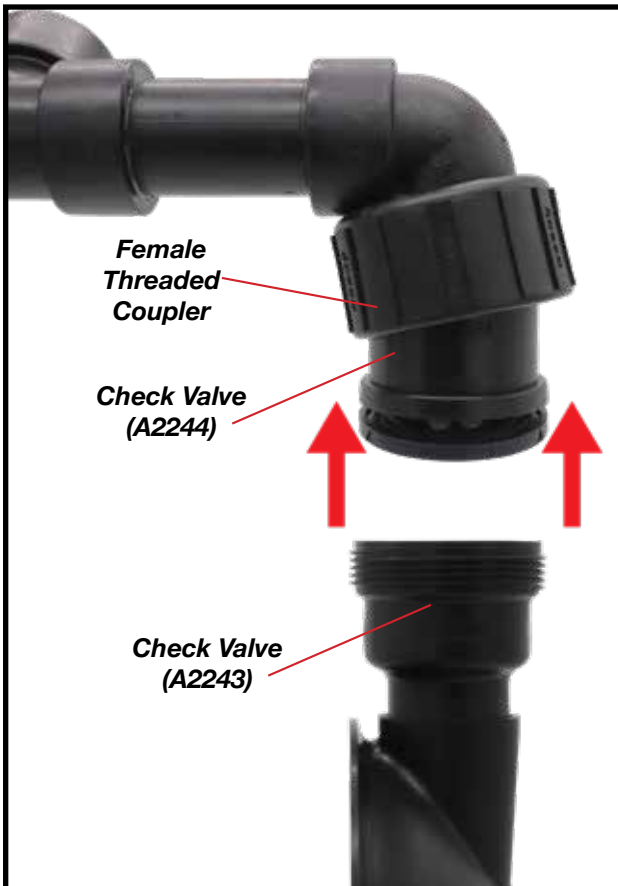

Changing Flapper Valves

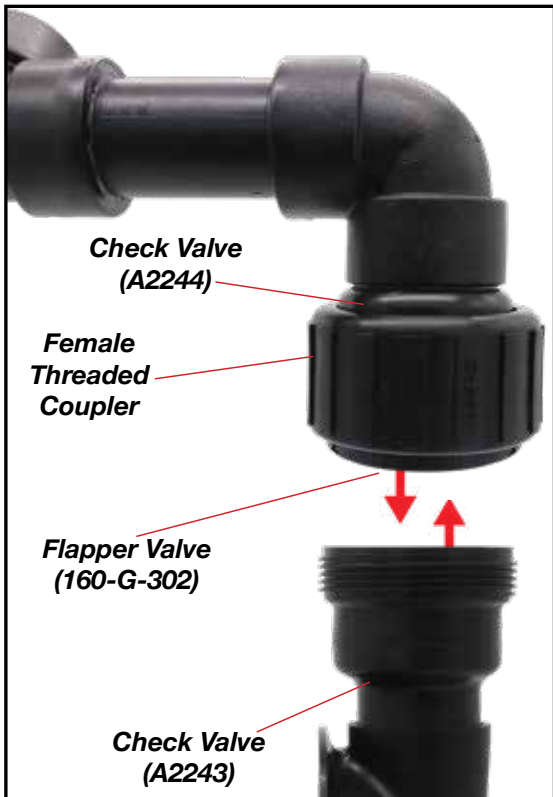

Step 3

Now that the **Flapper Valve (160-G-302)** is secured into the **Check Valve** with the **Part Number A2244** imprinted on, you can connect two the half's of the **Check Valve** together (**Part Number A2244 & Part Number A2243**, with the **Flapper Valve (160-G-302)** in the middle of it).

Once together, lock the two half's of the Check Valve (**Part Number A2244 & Part Number A2243**, with the **Flapper Valve (160-G-302)** in the middle of it) by twisting the **Female Threaded Coupler**. (Use a strap wrench to ensure a tight fit between the two half's A2244 & A2243).



Step 4

The **Check Valve (269P-150)** is secured tight with the **Flapper Valve (160-G-302)** in the correct position. You now have successfully changed one (of the four) Flapper Valves for Edson's 25200 Series Double Diaphragm Pumps with Union Polypropylene Check Valve.



269P-150 CHECK VALVE ASSEMBLED FOR SUCTION AND DISCHARGE

Important: In order for the pump to work the 269P-150 Check Valves must have the flapper valve oriented so it opens in the direction of flow and the flapper hinge is at the high side of the valve. Since the same check valve is used on the suction and discharge of the pump, the 160-G-302 replaceable flapper assembly was designed so it can be placed in the check valve oriented to open in either direction. When changing the flapper use the following pictures as a guide.

PUMP BASE



DISCHARGE PORT

DISCHARGE SIDE

269P-150 Check Valve Addembled with Flapper Valve oriented for discharge side of the pump base.

PUMP BASE