

THIS SCHEMATIC IS INTENDED TO PROVIDE AN OUTLINE FOR DESIGNING YOUR SYSTEM. COMPLETE INSTRUCTIONS FOR INSTALLATION CAN BE FOUND IN OUR "PLANNING & INSTALLATION GUIDE", WHICH CAN BE FOUND ON OUR WEBSITE.

**VISIT US ONLINE AT
WWW.EDSONMARINE.COM**

NOTE:
**WIRES MUST BE
CROSSED WITHIN
PEDESTAL FOR
PROPER STEERING
DIRECTION**

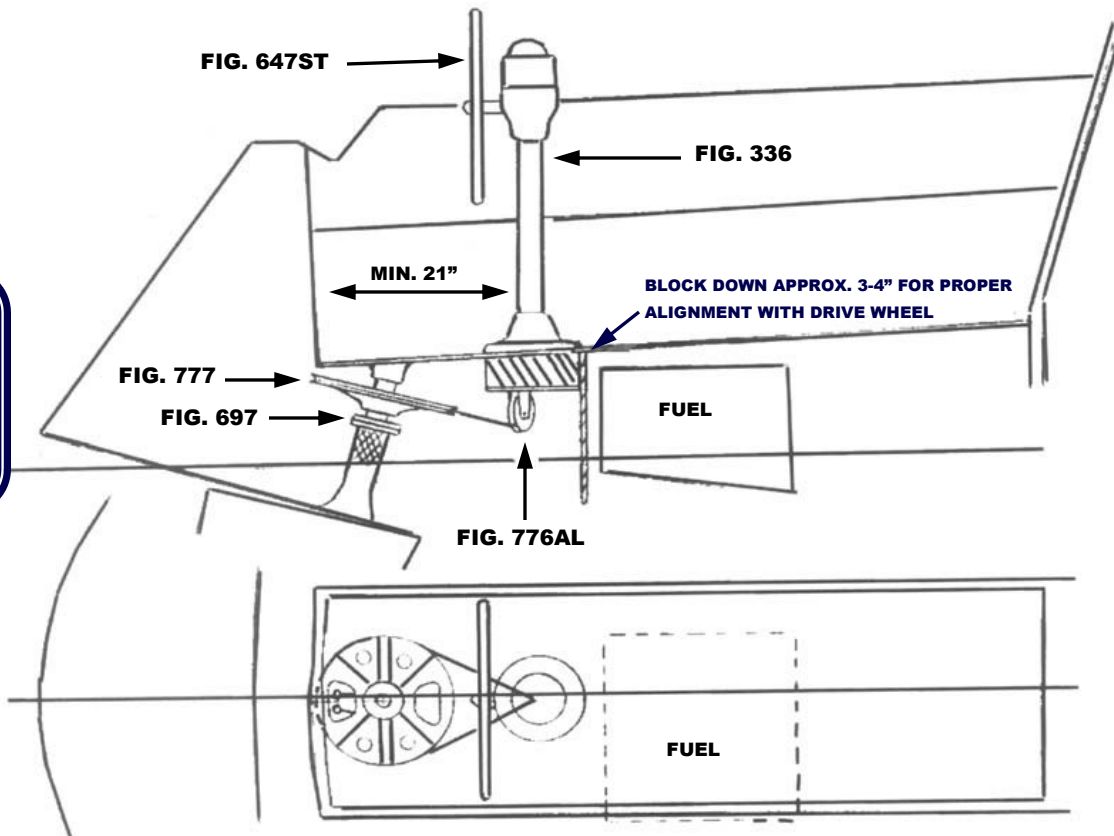

STEERING COMPONENTS:

- | | |
|--|--|
| 1 FIG. 336-5-211T | CLASSIC PEDESTAL STEERER/TAPERED |
| 1 FIG. 647ST-24-5 | DISHED DESTROYER WHEEL |
| 1 FIG. 77103 | CHAIN & WIRE ROPE KIT W/HARDWARE [was 774-2S15B9] |
| | <i>(1.5FT #50 CHAIN, 9FT 3/16" 7X19 305 SS WIRE ROPE)</i> |
| 1 FIG. 776AL-4AL | ADJUSTABLE CROSSED WIRE IDLER |
| 1 FIG. 800-8 | RADIAL DRIVE WHEEL |
| 4 FIG. 646-6HEX | PEDESTAL MOUNTING BOLTS |
| (A FIG. 697 STUFFING BOX/BEARING MAY BE REQUIRED) | |